

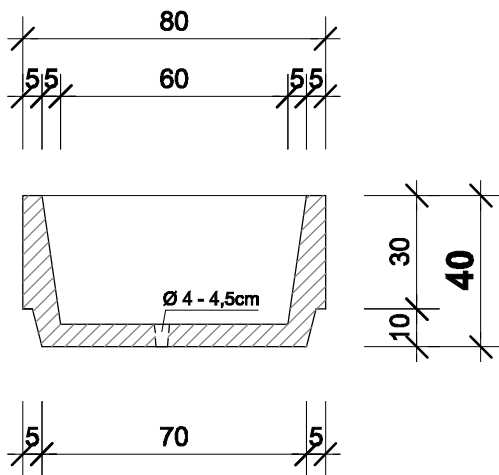

Schnitt A - A Maßstab 1:200

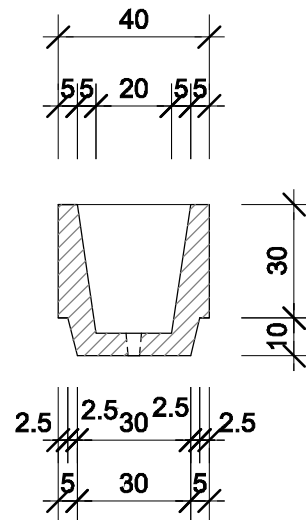

Schnitt B - B Maßstab 1:200



Draufsicht Maßstab 1:200

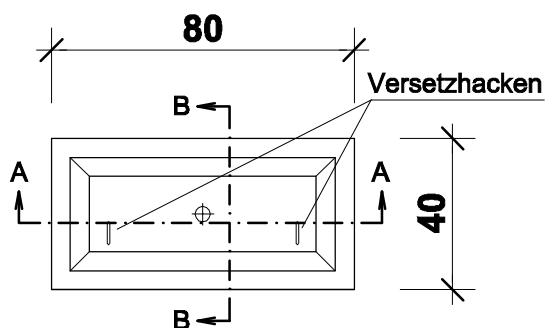

# BLUMENTROG

80



Loferer Bundesstraße 4  
5760 Saalfelden  
Tel. 06582 735 70  
E-Mail: info@ebenseer.at

www.ebenseer.at

BETONDECKUNG 3,0 cm	BETONGÜTE C25/30/B7	MASSTAB 1:200	DATUM 16.01.08
GEWICHT 149 kg	STAHLGÜTE BST 550	BEARBEITET LEM	FREIGEgeben 16.01.08